

MWP



:

1	4
2	6
3	7
3.1	7
3.1.1	7
3.2	7
3.3	8
3.4	10
4	11
4.1	11
4.2	11
4.3	11
4.3.1	12
4.4	12
4.4.1	12
5	13
5.1	13
5.1.1	13
5.1.2	14
5.1.3	14
5.2	14
5.2.1	14
5.2.2	15
5.2.3	15
5.3	15
5.3.1	(..... 100%).....	16
5.3.2	16
5.3.3	16
6	17
6.1	18
6.2	18
6.2.1	19
6.2.2 ,	20
6.2.3	20
6.2.4	21
6.2.5	22
6.2.6	23
6.2.7	24
6.2.8	25
6.2.9	26
6.2.10	27
6.2.11	28
7	29
8	31
9	32

:
• : **ZERO**

• , , , « □ ».

Благодарим за покупку лабораторных весов серии MWP производства фирмы CAS Corporation (Южная Корея); возможно производство на собственных производственных мощностях CAS Corporation в КНР с обязательной последующей диагностикой оборудования в Южной Корее. Просим ознакомиться с настоящим руководством прежде, чем приступить к работе с этими весами. Обращайтесь к нему в дальнейшем по необходимости.

MWP (-) 24104-2001

MWP : MWP-150, MWP-300, MWP-600, MWP-1500, MWP-3000, MWP-300H MWP-3000H.

() «Н»
()

• 8- ;
• () ;
• (, 100%);
• ;
• ;
• ;
• ;

23654 «
MW MWP»; 31533-06 26.04.06. :
II C 12.2.007.0.

8.520-84 «
»

12

- 12

- : 109263, , 7- . , .7, .1
.: +7 (495) 742-57-34
CAS: 109263, , 7- . , .7, .1
.: +7 (495) 742-57-34

<http://www.scale.ru>

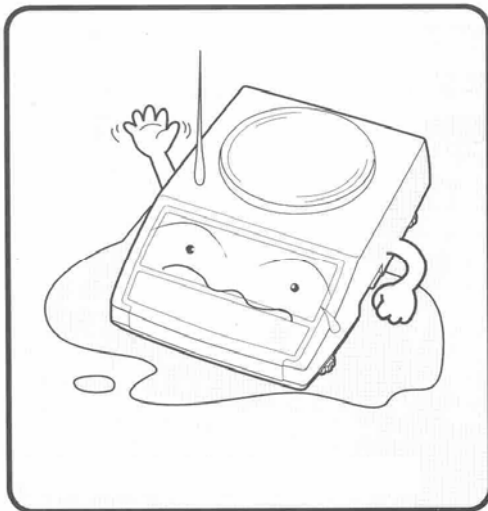
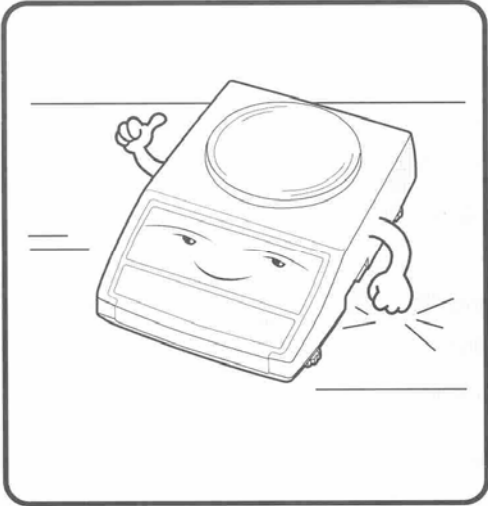

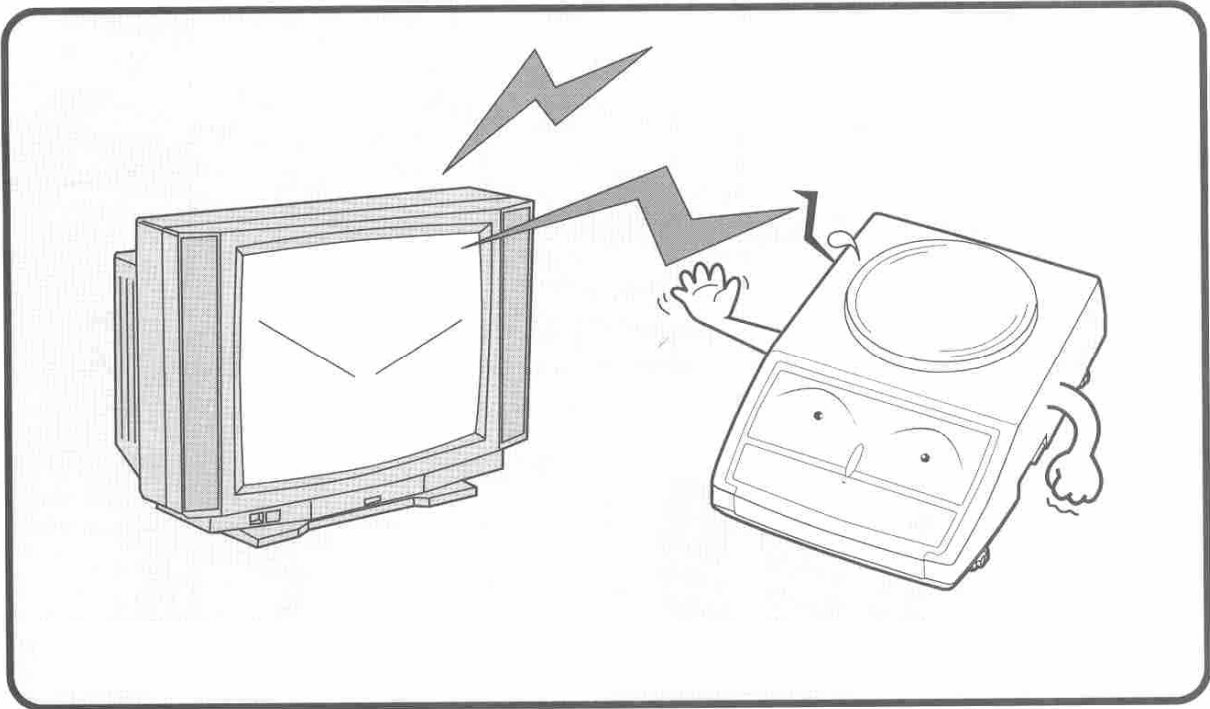
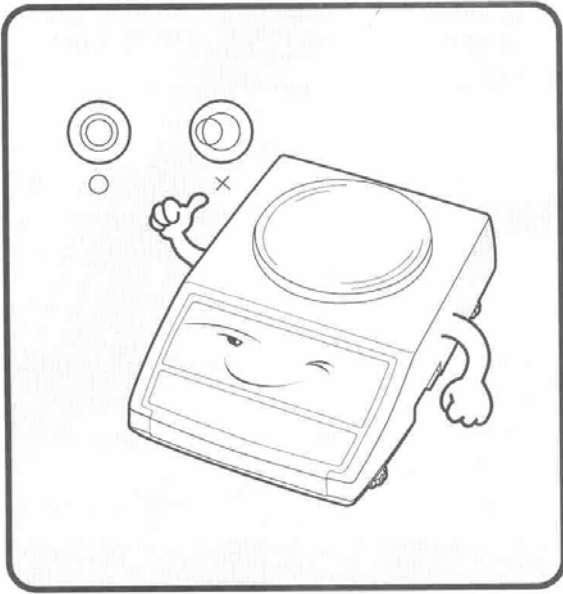

2

2.1

2.1 -

	- (.)		- (.)
WP	1		1
12 , 500-800	1		1
	1		1

3

3.1

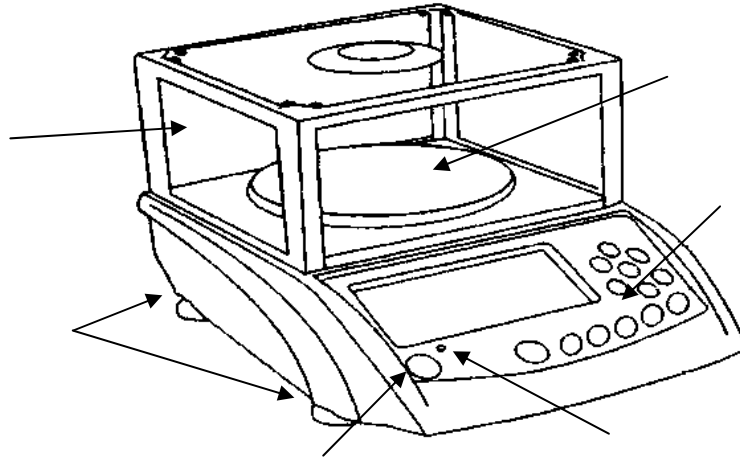

3.1 -

3.1.1

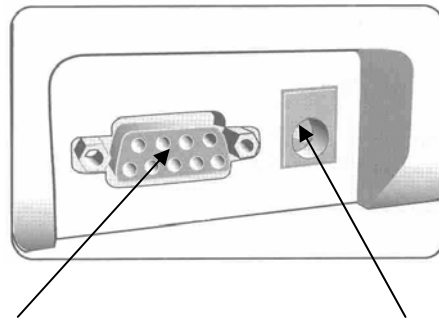

RS-232

3.2 -

3.2

3.3,

3.1.

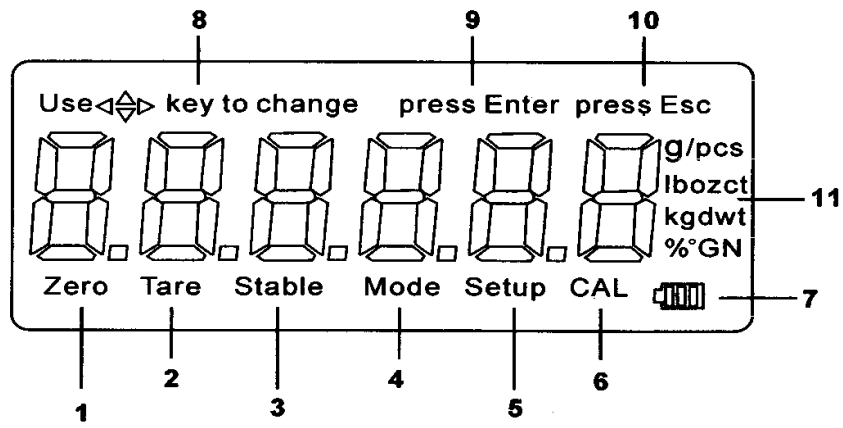

3.3 -

3.1 -

1	.
2	.
3	.
4	. ,
5	. , .
6	. , .
7	
8	:
9	: ENTER -
10	: ESC -
11	: ct - ; lb - ; oz - ; GN - ; oz t - ; dwt - ; t - ; pcs - (); % - .

3.3

3.2.

	
<div style="border: 1px solid black; padding: 2px; display: inline-block;">MODE</div>	⇔ (⇔) ⇔ : -
<div style="border: 1px solid black; padding: 2px; display: inline-block;">UNITS</div>	⇔ dwt ⇔ ⇔ g . . . : g ⇔ ct ⇔ lb ⇔ oz ⇔ GN ⇔ oz
<div style="border: 1px solid black; padding: 2px; display: inline-block;">PCS</div>	, 100%, -
<div style="border: 1px solid black; padding: 2px; display: inline-block;"><</div>	: .
<div style="border: 1px solid black; padding: 2px; display: inline-block;">></div>	: .
<div style="border: 1px solid black; padding: 2px; display: inline-block;"></div>	: .
<div style="border: 1px solid black; padding: 2px; display: inline-block;"></div>	: .
<div style="border: 1px solid black; padding: 2px; display: inline-block;">ENTER</div>	: ((), - () .
<div style="border: 1px solid black; padding: 2px; display: inline-block;">ESC</div>	: -
<div style="border: 1px solid black; padding: 2px; display: inline-block;">SETUP</div>	.
<div style="border: 1px solid black; padding: 2px; display: inline-block;">T</div>	.
<div style="border: 1px solid black; padding: 2px; display: inline-block;">0</div>	.

3.4

12

800 .

(DC),

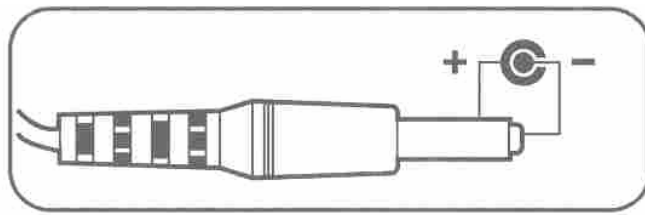

3.4 -

4

4.1

2.1.

(. . 4.1).

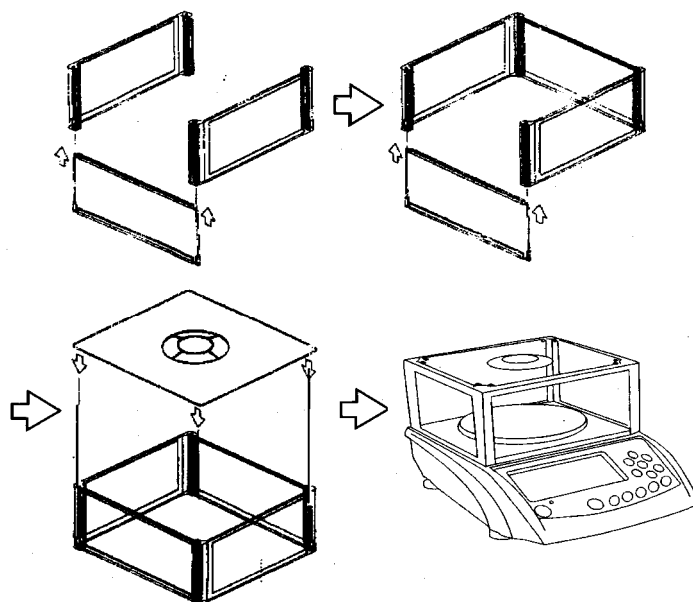

.4.1 -

(. . .1).

(. . .1) 4-

4.2

(. . 3.4).



4.3

8-

4.3.1

UNITS

UNITS.

UNITS ()

(. ' 3.2).

g↔ct↔lb↔oz↔GN↔oz t↔dwt↔t↔g . .

4.4

F2 (7328)

2/3

()

2/3

«MWP»

. 4.4.1.

(. . 6.2.1).

4.4.1

ENTER

□

3000



□



2-

□

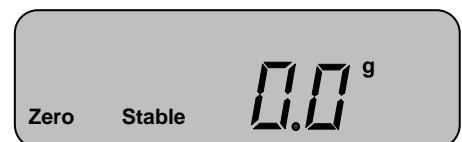

5

. 4.3.1.

- «Stable».
- «Zero»
0 .
- 0.8 .
-
- 3



5.1

5.1.1

()

- « » «ZERO».
- 0 .
- 0.3 .
- « ».
- T.

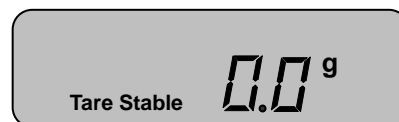
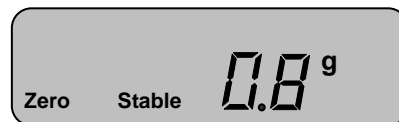

5.1.2

(. . 5.1.1.).

- 1,3



-



- 2

5.1.3

- T. «Tare»



5.2

(10, 20, 50 100),

5.2.1

- 10, 20, 50 100 :
- (.) (. 5.1).

5.1 -

	MWP-150	MWP-300	MWP-600	MWP-1500	MWP-3000	MWP-300H	MWP-3000H
	0.001	0.002	0.004	0.01	0.02	0.002	0.02

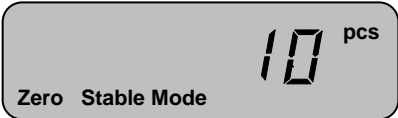
□ **MODE.** -10 . , 

UNITS ,

□ 

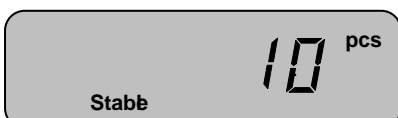
□ **PCS.** 

5.2.2

(. . 5.2.1).

□ 11 . , 

□ 

□ **5.2.3**

□ **MODE.** 

5.3

(), 100%.

5.3.1

(

100%)

- , 100%,
- :
- (. 5.1)

MODE.



PCS.



5.3.2

(. . 5.3.1).



2

5.3.3



MODE.



6.1,

6.1.

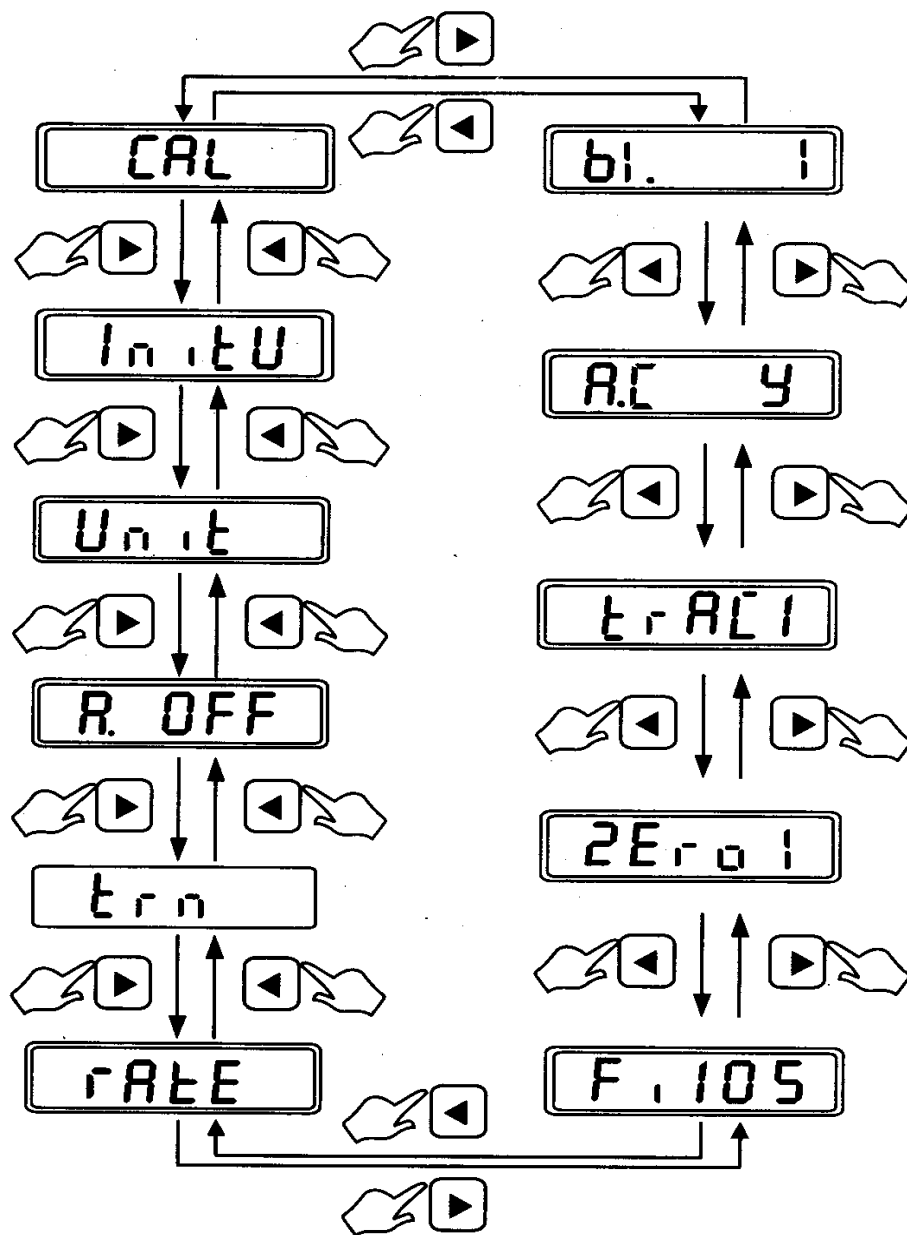

6.1 -

6.1 -

()	
CAL	()
Initu	,
Unit	
A. Off	
trn	
rAtE	RS-232
Fi105	(), -
2Erol	(), -
trac1	(), -
A.C Y	/
Bl. 1	

6.1

□

SETUP ()



6.2

), ENTER ESC. : (4 -
< >
,
ENTER
() (-
)
ESC

6.2.1

2/3

F2 (7328)

()

2/3

ENTER. (. . . 6.1.)

3000

Use < > key to change press Enter press Esc

3000.00

Setup

Use < > key to change press Enter press Esc

2000.00

Setup

2

ENTER.

press Esc

2000.00

Stable CAL

2000.00^g

Stable

Zero Stable 0.0^g

6.2.2

- (. . 6.1.)
ENTER.

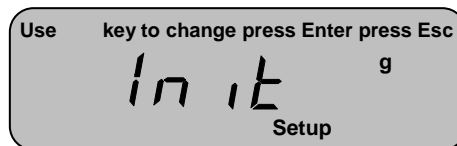

- (. . 6.1.)
ENTER.

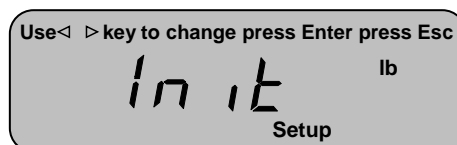

- ENTER.

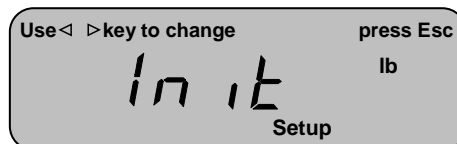

- ESC.
- ESC

6.2.3

- (. . 6.1.)
ENTER.

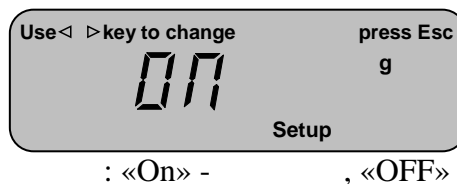

- (. . 6.1.)
ENTER.



□

ENTER.



□

ESC.

□

ESC.

6.2.4

- ;

- 2- ;

- 5- ;

- 8- .

- 2- -

6.2 -

()	
nO	.
YES2	2-
YES5	5-
YES8	8-

□

ENTER.

(. . 6.1.)
> , -



, «YES2».

5.

□

,
ENTER.

«YES8».



□

ESC.

□

ESC.

6.2.5

6.3.

6.3 –

()	
CLOSE	
tb	ENTER.
stb	
ser	

- (. . 6.1.)

ENTER.

(. . 6).

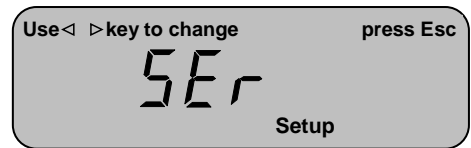

- «tb».
- ENTER.**

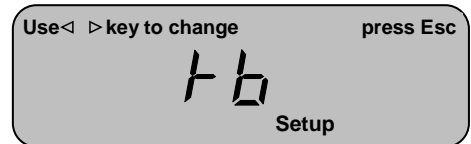

- **ESC.**
- **ESC.**

6.2.6

: 1200, 2400, 4800 9600 / .

2400 / .

□

ENTER.

(. . . 6.1.)
> , -



□

«9600».

ENTER.



□

ESC.

□

ESC.

6.2.7

,) , () . - (- :
, , . (-
,) , (-
,) , (-
- «05».

□ (. . 6.1.)
> .
, «05».

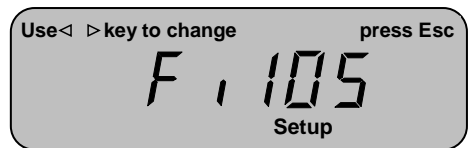

□
, «06».
ENTER.



□ **ESC.**
□ **ESC.**

6.2.8

,) , () . - (- :
, , . (-
, , , . -
- «05».

□ (. . 6.1.)
< .



«1».

□
, «2».
ENTER.



□ **ESC.**
□ **ESC.**

6.2.9

(), (,). , - -

□ (. . 6.1.)

< .



“1”.

□

,
ENTER.

«3».



ESC

□

□

ESC.

6.2.10

- (. . . 6.1.)
< .
, , «y».

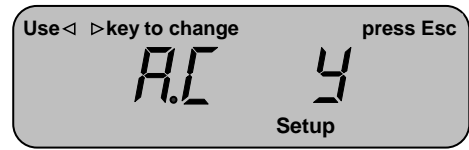

- : «y» - , «n» -
ENTER.



- ESC.
- ESC.

6.2.11

1.

2.

3.

□

(. . 6.1.)

< .

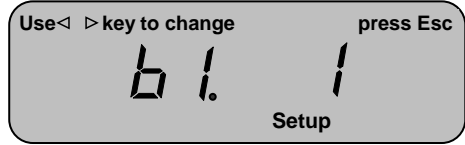

, «1».

□

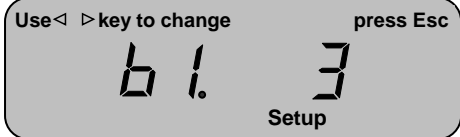

«3».

ENTER.

□

ESC.

□

ESC.

7

RS-232C USB (, -
). (RS-232) 7.1, 9-
 7.2, -

7.1 -

, /	2400 4800
	7
	1
	1
	ASCII

7.2 -

RS-232C

2	
3	
5	« »

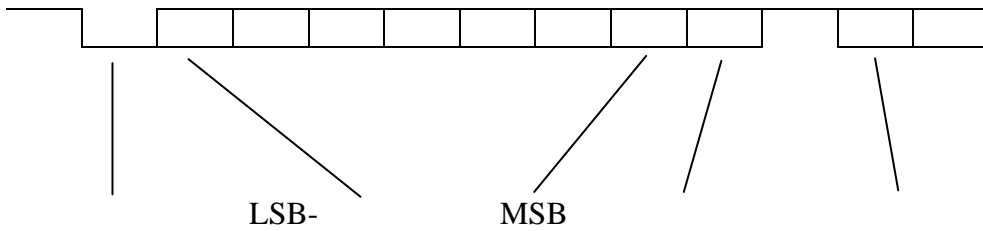

7.1

():

1 2 3 4 5 6 7 8 9 10 11 12 13 14 15 16 17 18 19 20.

7.3.

7.3 –

()		
1, 2	1	«OL» – ; «ST» – ; «US» -
3		«.,»
4, 5	2	«NT» – ; «GS» –
6		«.,»
7, 8, 9, 10, 11, 12, 13, 14		(-): «2D» – « »; «2E» – «.» (); «20» – « » ().
15, 16, 17, 18	-	: «g» - «20», «20», «20», «67» : «lb» - «20», «20», «6C», «62» : «tl.T» - «74», «6C», «2E», «54»
19, 20	-	: «0D», «0A».

(0,876 ; -):

ST, NT, + 0.876 g 0D 0A

8

8.1.

8.1 –

	MWP-150	MWP-300	MWP-600	MWP-1500	MWP-3000	MWP-300H	MWP-3000H
	150	300	600	1500	3000	300	3000
	0.005	0.01	0.02	0.05	0.1	0.01	0.1
	0.005	0.01	0.02	0.05	0.1	0.005	0.05
(24104-2001)	0,005 (25 .); 0,01 (25 100 .); 0,015 (100)	0,01 (50 .); 0,02 (50 200 .); 0,03 (200)	0,02 (100 .); 0,04 (100 400 .); 0,06 (400)	0,05 (250 .); 0,1 (250 1000 .); 0,15 (1000)	0,1 (500 .); 0,2 (500 2000 .); 0,3 (2000)	0,01 (50 .); 0,02 (50 200 .); 0,03 (200)	0,1 (500 .); 0,2 (500 2000 .); 0,3 (2000)
	150	300	600	1500	3000	300	3000
	8						
	6-						
	3						
	0 ~ + 40						
	220 6 , 1.3						
	10 100%						
	80						
	RS-232 USB ()						
	= 116		124 144		= 116		144 , 124
	200 80 250						
	1,4						

9

, ,
12 . 9.1
: . : _____

9.1 –

N /		-	-	